

Module 3: Operating-System Structures

By,

Sr. Nisha C D
Assistant Professor, Dept Of Computer Science
LF College, Guruvayoor

Module 3: Operating-System Structures

- System Components
- Operating System Services
- System Calls
- System Programs
- System Structure
- Virtual Machines
- System Design and Implementation
- System Generation

Common System Components

- Process Management
- Main Memory Management
- Secondary-Storage Management
- I/O System Management
- File Management
- Protection System
- Networking
- Command-Interpreter System

Process Management

- A *process* is a program in execution. A process needs certain resources, including CPU time, memory, files, and I/O devices, to accomplish its task.
- The operating system is responsible for the following activities in connection with process management.
 - Process creation and deletion.
 - process suspension and resumption.
 - Provision of mechanisms for:
 - * process synchronization
 - * process communication

Main-Memory Management

- Memory is a large array of words or bytes, each with its own address. It is a repository of quickly accessible data shared by the CPU and I/O devices.
- Main memory is a volatile storage device. It loses its contents in the case of system failure.
- The operating system is responsible for the following activities in connections with memory management:
 - Keep track of which parts of memory are currently being used and by whom.
 - Decide which processes to load when memory space becomes available.
 - Allocate and deallocate memory space as needed.

Secondary-Storage Management

- Since main memory (*primary storage*) is volatile and too small to accommodate all data and programs permanently, the computer system must provide *secondary storage* to back up main memory.
- Most modern computer systems use disks as the principle on-line storage medium, for both programs and data.
- The operating system is responsible for the following activities in connection with disk management:
 - Free space management
 - Storage allocation
 - Disk scheduling

I/O System Management

- The I/O system consists of:
 - A buffer-caching system
 - A general device-driver interface
 - Drivers for specific hardware devices

File Management

- A file is a collection of related information defined by its creator. Commonly, files represent programs (both source and object forms) and data.
- The operating system is responsible for the following activities in connections with file management:
 - File creation and deletion.
 - Directory creation and deletion.
 - Support of primitives for manipulating files and directories.
 - Mapping files onto secondary storage.
 - File backup on stable (nonvolatile) storage media.

Protection System

- *Protection* refers to a mechanism for controlling access by programs, processes, or users to both system and user resources.
- The protection mechanism must:
 - distinguish between authorized and unauthorized usage.
 - specify the controls to be imposed.
 - provide a means of enforcement.

Networking (Distributed Systems)

- A *distributed* system is a collection processors that do not share memory or a clock. Each processor has its own local memory.
- The processors in the system are connected through a communication network.
- A distributed system provides user access to various system resources.
- Access to a shared resource allows:
 - Computation speed-up
 - Increased data availability
 - Enhanced reliability

Command-Interpreter System

- Many commands are given to the operating system by control statements which deal with:
 - process creation and management
 - I/O handling
 - secondary-storage management
 - main-memory management
 - file-system access
 - protection
 - networking

Command-Interpreter System (Cont.)

- The program that reads and interprets control statements is called variously:
 - control-card interpreter
 - command-line interpreter
 - shell (in UNIX)

Its function is to get and execute the next command statement.

Operating System Services

- Program execution – system capability to load a program into memory and to run it.
- I/O operations – since user programs cannot execute I/O operations directly, the operating system must provide some means to perform I/O.
- File-system manipulation – program capability to read, write, create, and delete files.
- Communications – exchange of information between processes executing either on the same computer or on different systems tied together by a network. Implemented via *shared memory* or *message passing*.
- Error detection – ensure correct computing by detecting errors in the CPU and memory hardware, in I/O devices, or in user programs.

Additional Operating System Functions

Additional functions exist not for helping the user, but rather for ensuring efficient system operations.

- Resource allocation – allocating resources to multiple users or multiple jobs running at the same time.
- Accounting – keep track of and record which users use how much and what kinds of computer resources for account billing or for accumulating usage statistics.
- Protection – ensuring that all access to system resources is controlled.

System Calls

- System calls provide the interface between a running program and the operating system.
 - Generally available as assembly-language instructions.
 - Languages defined to replace assembly language for systems programming allow system calls to be made directly (e.g., C. Bliss, PL/360)
- Three general methods are used to pass parameters between a running program and the operating system.
 - Pass parameters in *registers*.
 - Store the parameters in a table in memory, and the table address is passed as a parameter in a register.
 - *Push* (store) the parameters onto the *stack* by the program, and *pop* off the stack by operating system.

Passing of Parameters As A Table

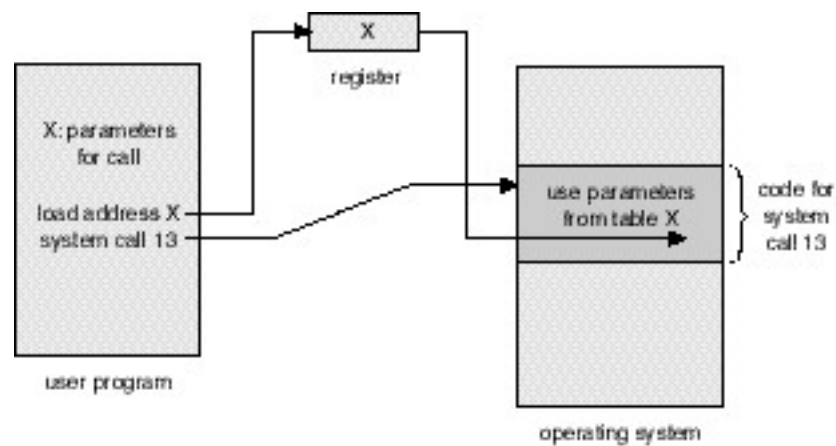

MS-DOS Execution

At System Start-up

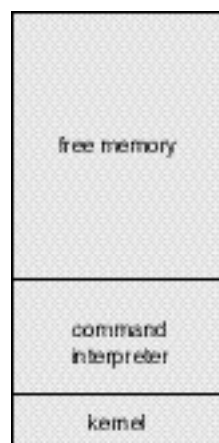

(a)

Running a Program

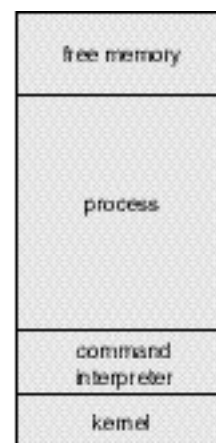

(b)

UNIX Running Multiple Programs

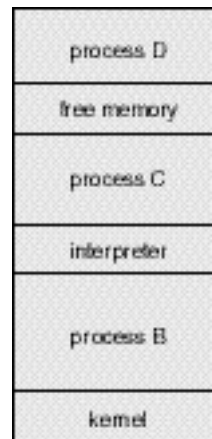

Communication Models

Msg Passing

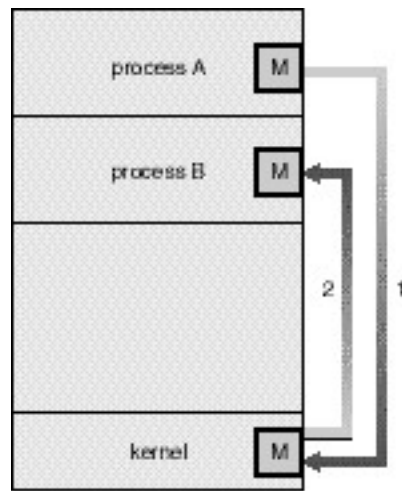

(a)

Shared Memory

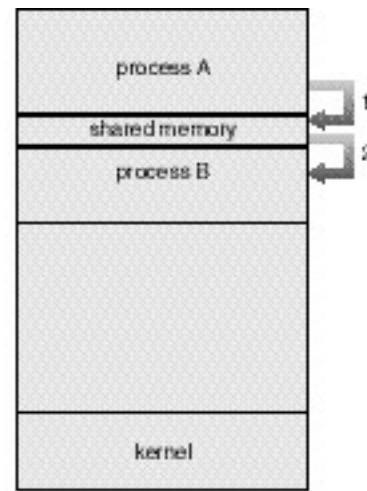

(b)

System Programs

- System programs provide a convenient environment for program development and execution. They can be divided into:
 - File manipulation
 - Status information
 - File modification
 - Programming language support
 - Program loading and execution
 - Communications
 - Application programs
- Most users' view of the operation system is defined by system programs, not the actual system calls.

System Structure – Simple Approach

- MS-DOS – written to provide the most functionality in the least space
 - not divided into modules
 - Although MS-DOS has some structure, its interfaces and levels of functionality are not well separated

MS-DOS Layer Structure

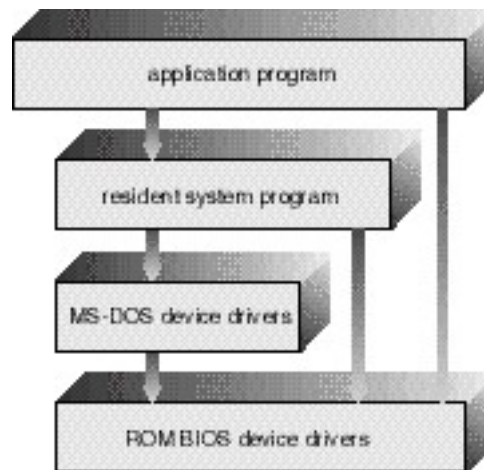

System Structure – Simple Approach (Cont.)

- UNIX – limited by hardware functionality, the original UNIX operating system had limited structuring. The UNIX OS consists of two separable parts.
 - Systems programs
 - The kernel
 - * Consists of everything below the system-call interface and above the physical hardware
 - * Provides the file system, CPU scheduling, memory management, and other operating-system functions; a large number of functions for one level.

UNIX System Structure

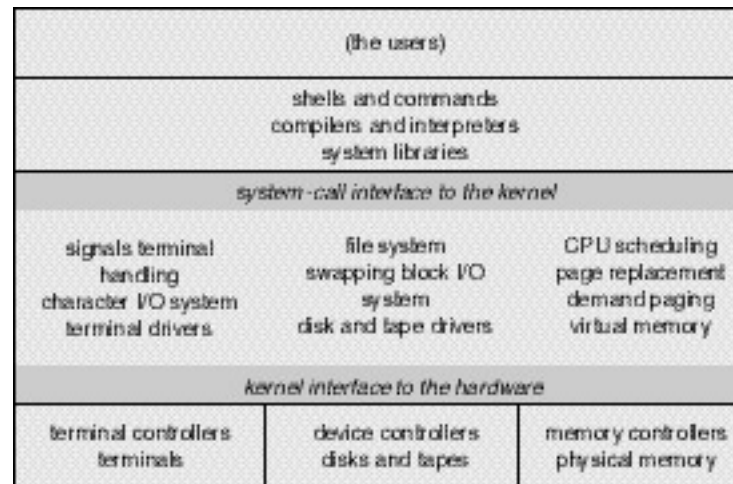

System Structure – Layered Approach

- The operating system is divided into a number of layers (levels), each built on top of lower layers. The bottom layer (layer 0), is the hardware; the highest (layer N) is the user interface.
- With modularity, layers are selected such that each uses functions (operations) and services of only lower-level layers.

An Operating System Layer

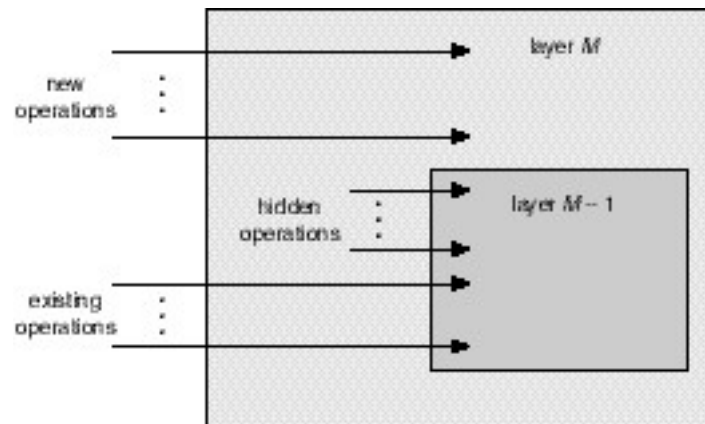

Layered Structure of the THE OS

- A layered design was first used in THE operating system. Its six layers are as follows:

layer 5: user programs

layer 4: buffering for input and output

layer 3: operator-console device driver

layer 2: memory management

layer 1: CPU scheduling

layer 0: hardware

OS/2 Layer Structure

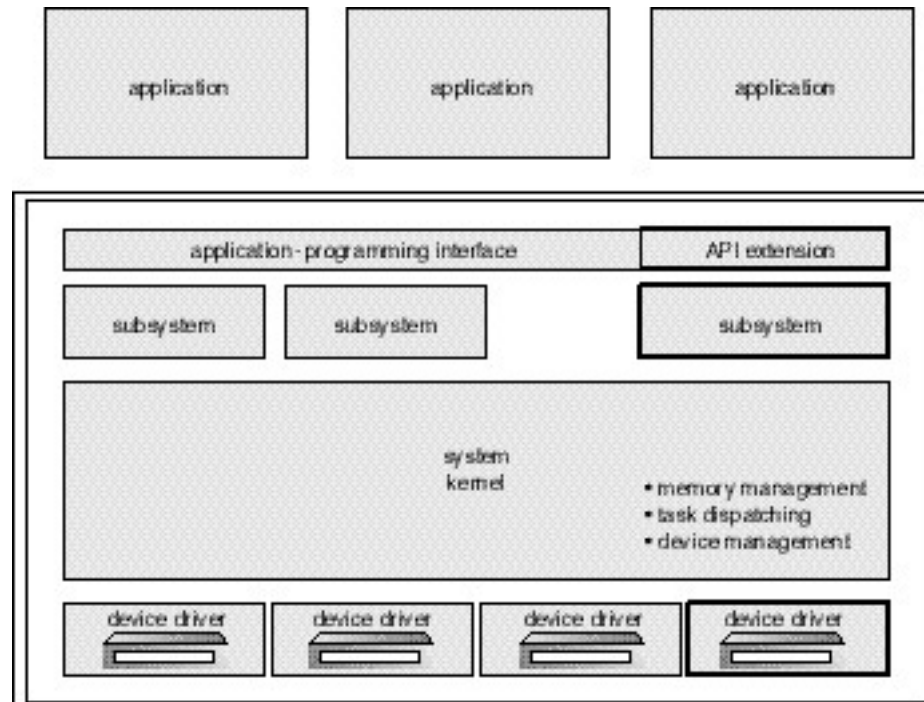

Virtual Machines

- A *virtual machine* takes the layered approach to its logical conclusion. It treats hardware and the operating system kernel as though they were all hardware.
- A virtual machine provides an interface *identical* to the underlying bare hardware.
- The operating system creates the illusion of multiple processes, each executing on its own processor with its own (virtual) memory.

Virtual Machines (Cont.)

- The resources of the physical computer are shared to create the virtual machines.
 - CPU scheduling can create the appearance that users have their own processor.
 - Spooling and a file system can provide virtual card readers and virtual line printers.
 - A normal user time-sharing terminal serves as the virtual machine operator's console.

System Models

Non-virtual Machine

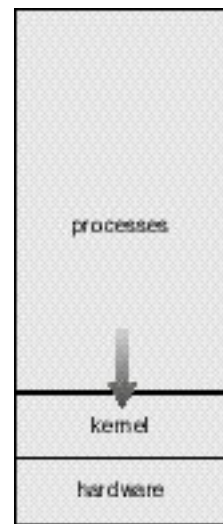

(a)

Virtual Machine

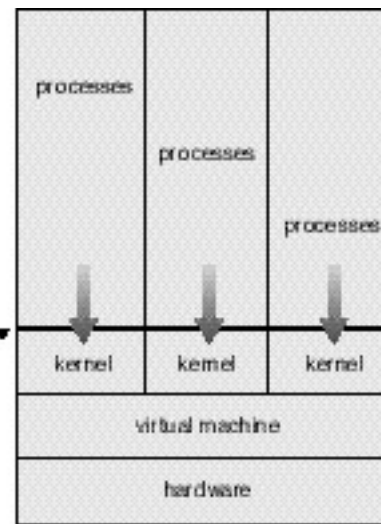

(b)

Advantages/Disadvantages of Virtual Machines

- The virtual-machine concept provides complete protection of system resources since each virtual machine is isolated from all other virtual machines. This isolation, however, permits no direct sharing of resources.
- A virtual-machine system is a perfect vehicle for operating-systems research and development. System development is done on the virtual machine, instead of on a physical machine and so does not disrupt normal system operation.
- The virtual machine concept is difficult to implement due to the effort required to provide an *exact* duplicate to the underlying machine.

System Design Goals

- User goals – operating system should be convenient to use, easy to learn, reliable, safe, and fast.
- System goals – operating system should be easy to design, implement, and maintain, as well as flexible, reliable, error-free, and efficient.

Mechanisms and Policies

- Mechanisms determine how to do something, policies decide what will be done.
- The separation of policy from mechanism is a very important principle, it allows maximum flexibility if policy decisions are to be changed later.

System Implementation

- Traditionally written in assembly language, operating systems can now be written in higher-level languages.
- Code written in a high-level language:
 - can be written faster.
 - is more compact.
 - is easier to understand and debug.
- An operating system is far easier to *port* (move to some other hardware) if it is written in a high-level language.

System Generation (SYSGEN)

- Operating systems are designed to run on any of a class of machines; the system must be configured for each specific computer site.
- SYSGEN program obtains information concerning the specific configuration of the hardware system.
- *Booting* – starting a computer by loading the kernel.
- *Bootstrap program* – code stored in ROM that is able to locate the kernel, load it into memory, and start its execution.